

Cylindrical fuse links

▀ Cylindrical fuse link 8 x 31 mm characteristic gG



ISZ08012

▀ Schrack-Info

- Cylindrical fuses according to IEC- standard sizes 8 x 31 mm
- Contacts silver-galvanized

Size:	8 x 31
Characteristic:	gG
Rated current:	1 - 25 A
Rated voltage:	400 V-AC
Rated frequency:	50 Hz
Rated breaking capacity:	50 kA
Body material:	ceramic
Material of contact parts:	CuZn28, gal.Ag



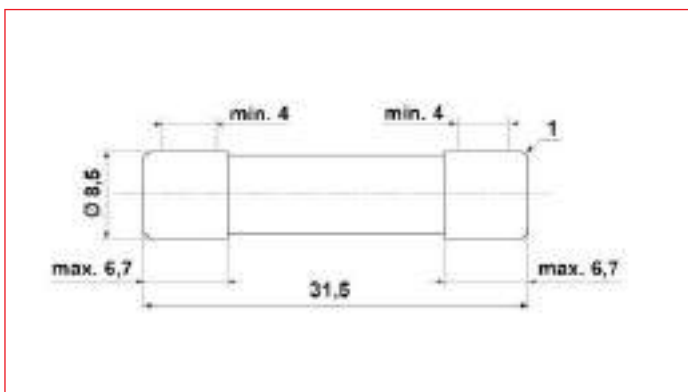

▀ 8 x 31 Dimensions

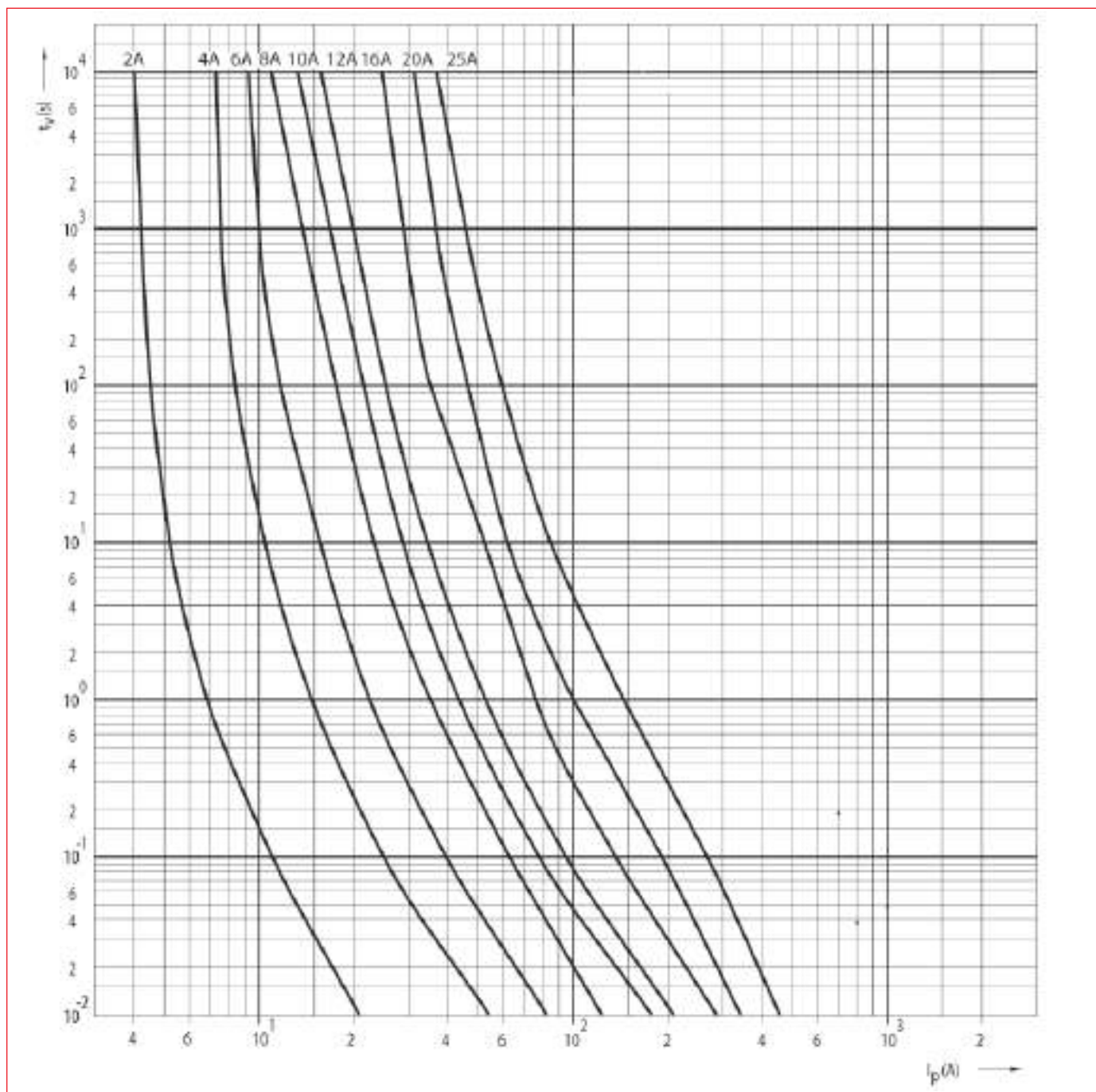

■ Cylindrical fuse link 8 x 31 mm characteristic gG

■ 8 x 31 Characteristic gG



DESCRIPTION	AVAILABLE	ORDER NO.
1A, 400V, gG, 8x31		ISZ08001
2A, 400V, gG, 8x31		ISZ08002
4A, 400V, gG, 8x31		ISZ08004
6A, 400V, gG, 8x31		ISZ08006
8A, 400V, gG, 8x31		ISZ08008
10A, 400V, gG, 8x31		ISZ08010
12A, 400V, gG, 8x31		ISZ08012
16A, 400V, gG, 8x31		ISZ08016
20A, 400V, gG, 8x31		ISZ08020
25A, 400V, gG, 8x31		ISZ08025

Cylindrical fuse links

▀ Cylindrical fuse link 10 x 38 mm characteristic gG



▀ Schrack-Info

- Cylindrical fuses according to IEC- standard sizes 10 x 38 mm
- Contacts silver-galvanized

ISZ100005

Size:	10 x 38
Characteristic:	gG
Rated current:	0,5 A - 32 A
Rated voltage:	500 V-AC
Rated frequency:	50 Hz
Rated breaking capacity:	100 kA
Body material:	ceramic
Material of contact parts:	CuZn28, gal.Ag

▀ 10 x 38 Dimensions

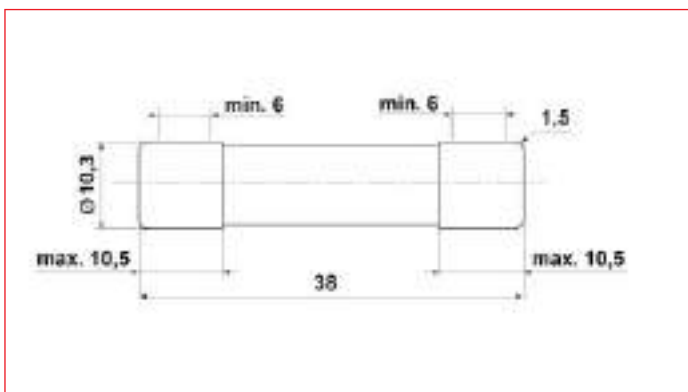





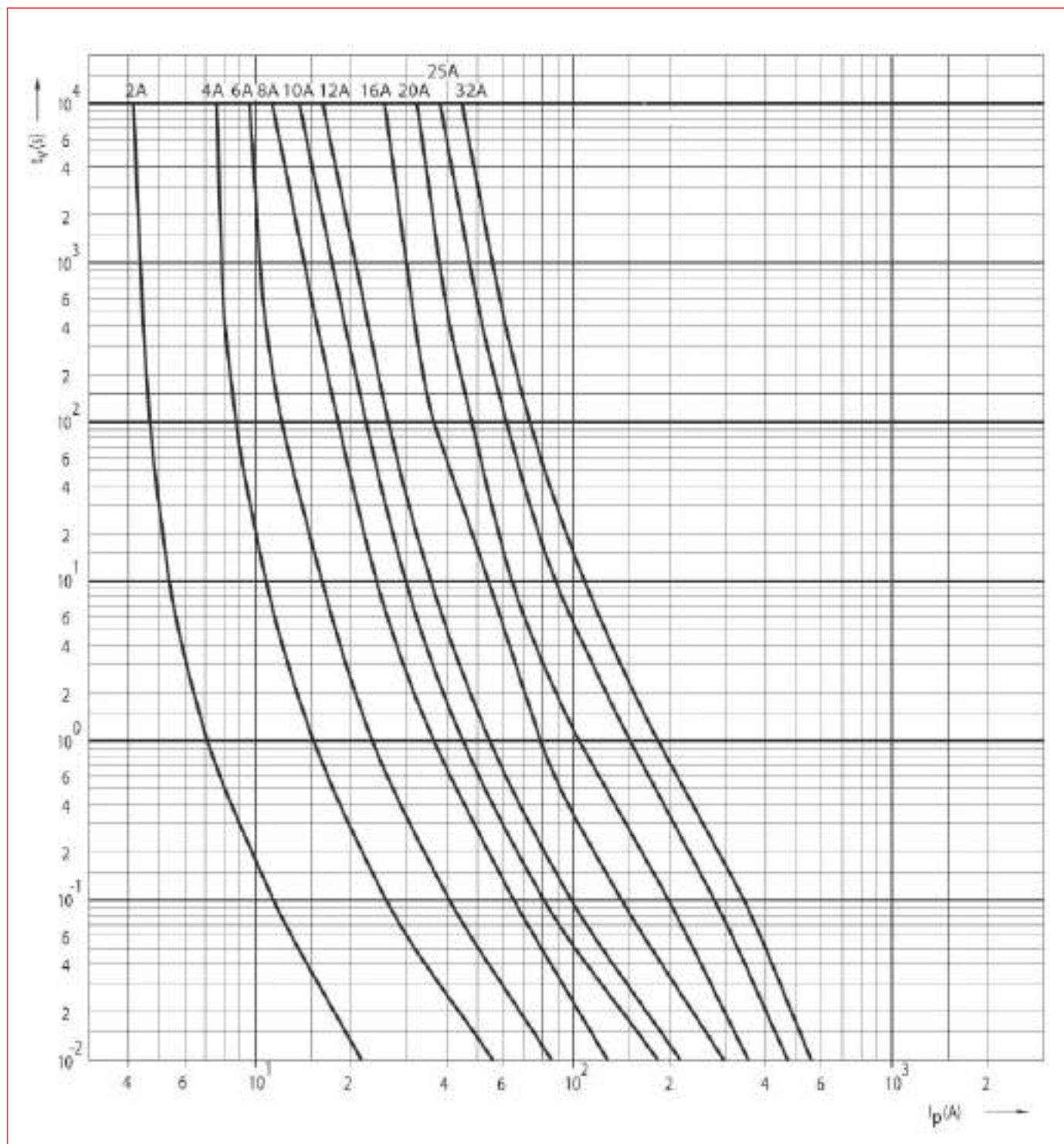







▀ Cylindrical fuse link 10 x 38 mm characteristic gG

▀ 10 x 38 Characteristic gG



Cylindrical fuse links

■ Cylindrical fuse link 10 x 38 mm characteristic gG

DESCRIPTION	AVAILABLE	ORDER NO.
0,5A, 500V, gG, 10x38		ISZ10005
1A, 500V, gG, 10x38		ISZ10001
2A, 500V, gG, 10x38		ISZ10002
4A, 500V, gG, 10x38		ISZ10004
6A, 500V, gG, 10x38		ISZ10006
8A, 500V, gG, 10x38		ISZ10008
10A, 500V, gG, 10x38		ISZ10010
12A, 500V, gG, 10x38		ISZ10012
16A, 500V, gG, 10x38		ISZ10016
16A, 500V, gG, 10 x 38		SI311860
20A, 500V, gG, 10x38		ISZ10020
25A, 500V, gG, 10x38		ISZ10025
32A, 400V, gG, 10x38		ISZ10032

■ Cylindrical fuse link 14 x 51 mm characteristic gG



ISZ14002

■ Schrack-Info

- Cylindrical fuses according to IEC- standard sizes 14 x 51 mm
- Contacts silver-galvanized

Size of fuse:	14 x 51
Characteristic:	gG
Rated current:	2 A - 50 A
Rated voltage:	690 V-AC
Rated frequency:	50 Hz
Rated short circuit making capacity:	2-25 A/80 kA, 32-50 A/120 kA
Material of cover:	Ceramic
Material off contacts:	CuZn28, gal.Ag

■ 14 x 51 Dimensions

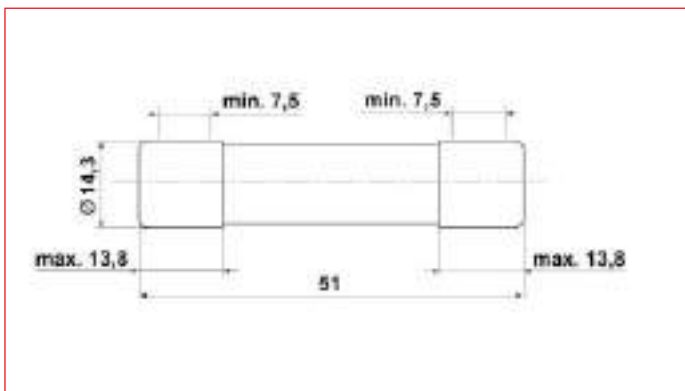





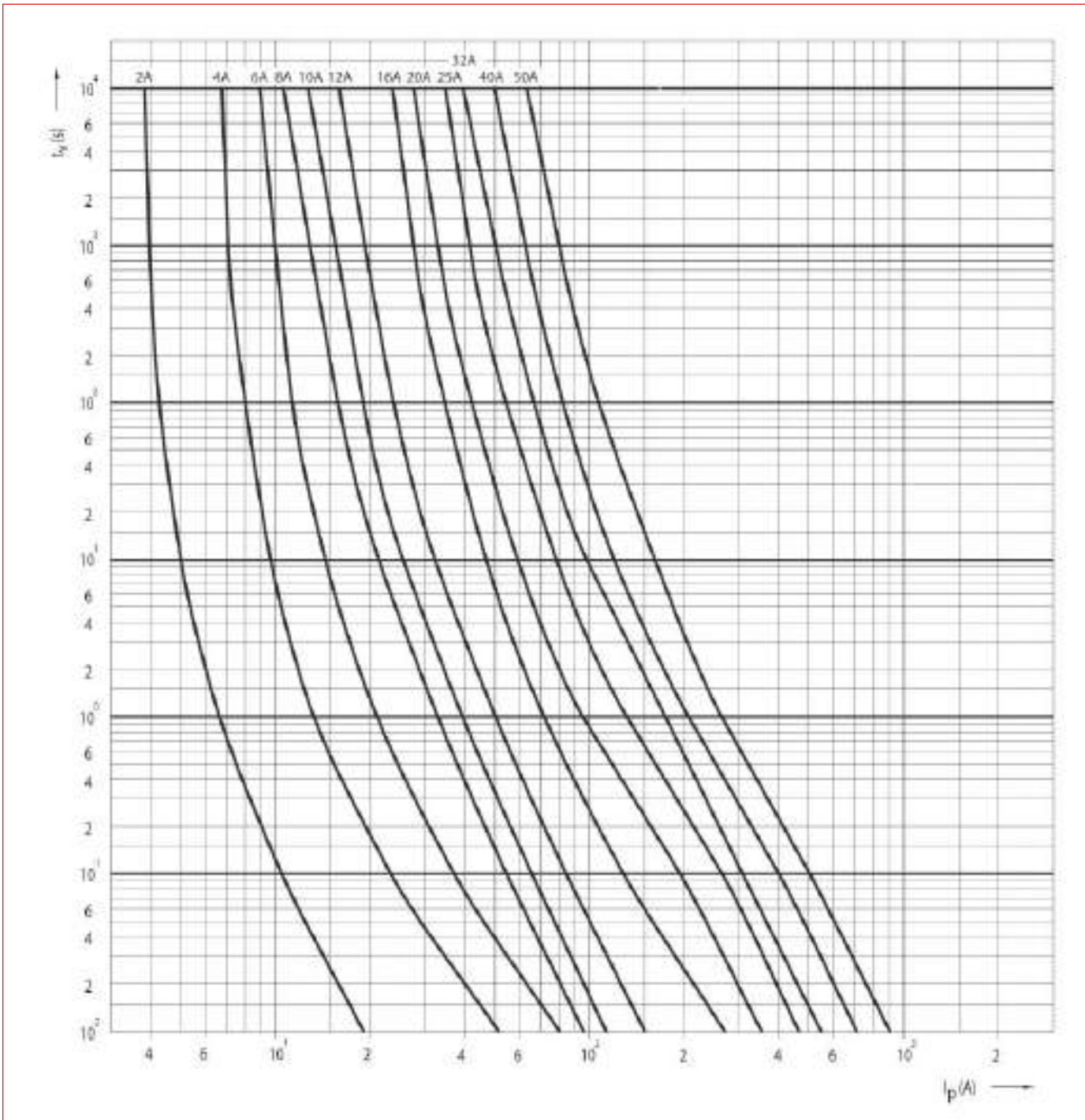



▀ Cylindrical fuse link 14 x 51 mm characteristic gG

▀ 14 x 51 Characteristic gG



Cylindrical fuse links

■ Cylindrical fuse link 14 x 51 mm characteristic gG

DESCRIPTION	AVAILABLE	ORDER NO.
2A, 690V, gG, 14x51		ISZ14002
4A, 690V, gG, 14x51		ISZ14004
6A, 690V, gG, 14x51		ISZ14006
8A, 690V, gG, 14x51		ISZ14008
10A, 690V, gG, 14x51		ISZ14010
12A, 690V, gG, 14x51		ISZ14012
16A, 690V, gG, 14x51		ISZ14016
20A, 690V, gG, 14x51		ISZ14020
25A, 690V, gG, 14x51		ISZ14025
32A, 690V, gG, 14x51		ISZ14032
40A, 500V, gG, 14x51		ISZ14040
50A, 500V, gG, 14x51		ISZ14050

■ Cylindrical fuse link 22 x 58 mm characteristic gG



ISZ22016

■ Schrack-Info

- Cylindrical fuses according to IEC- standard sizes 22 x 58 mm
- Contacts silver-galvanized

Size:	22 x 58
Characteristic:	gG
Rated current:	16 A - 125 A
Rated voltage:	690 V-AC
Rated frequency:	50 Hz
Rated breaking capacity:	16-40 A/80 kA (50 A/80 kA aM), 50-100 A/120 kA
Body material:	ceramic
Material of contact parts:	CuZn28, gal.Ag

■ 22 x 58 Dimensions

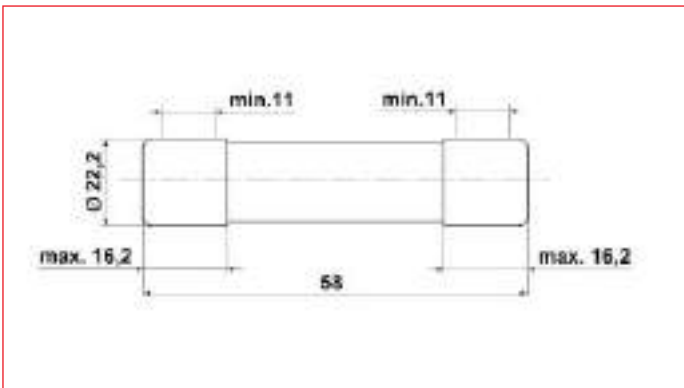

▀ Cylindrical fuse link 22 x 58 mm characteristic gG

▀ 22 x 58 Characteristic gG

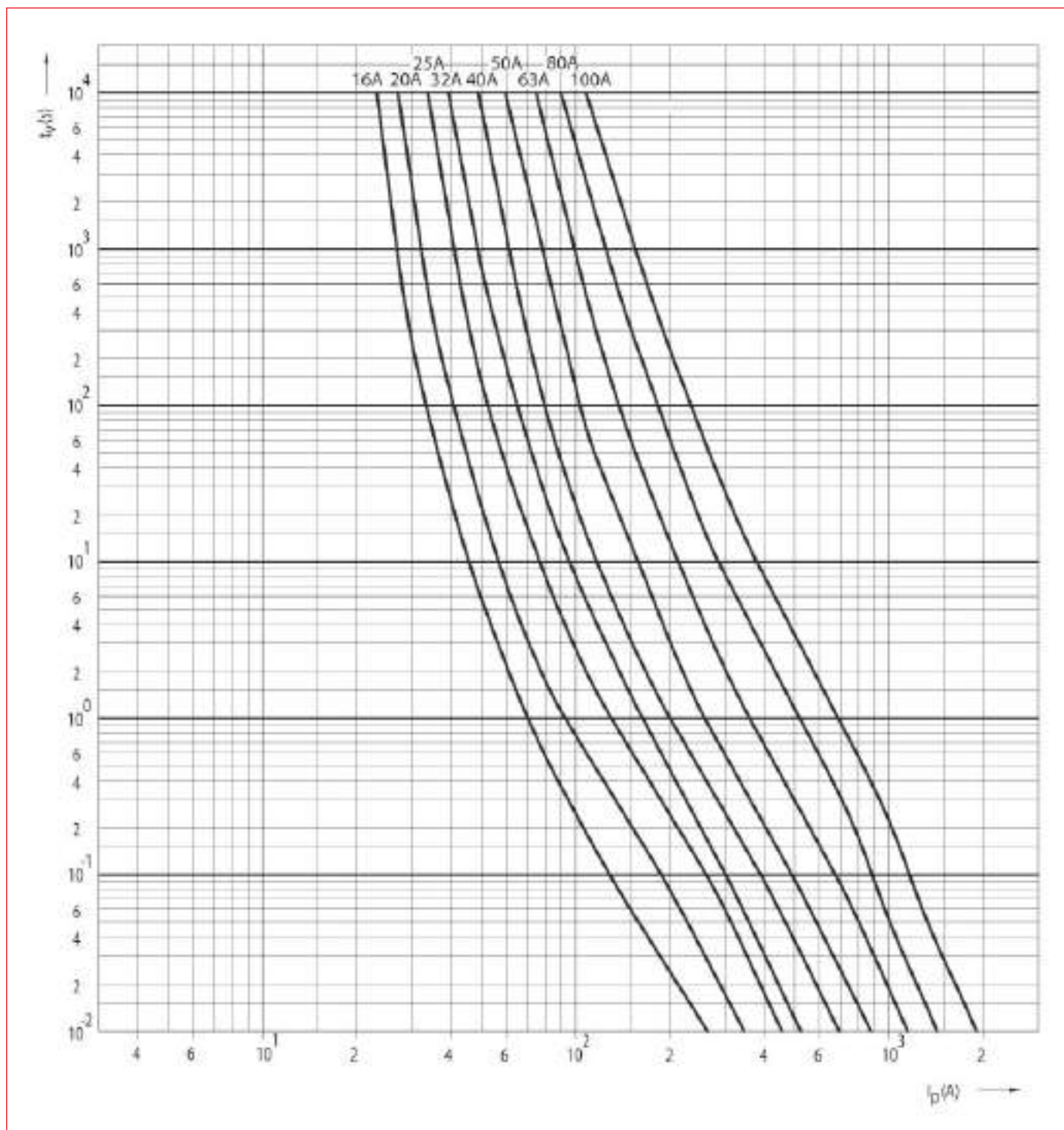

DESCRIPTION	AVAILABLE	ORDER NO.
16A, 690V, gG, 22x58		ISZ22016
20A, 690V, gG, 22x58		ISZ22020
25A, 690V, gG, 22x58		ISZ22025
32A, 690V, gG, 22x58		ISZ22032
40A, 690V, gG, 22x58		ISZ22040
50A, 500V, gG, 22x58		ISZ22050
63A, 500V, gG, 22x58		ISZ22063
80A, 500V, gG, 22x58		ISZ22080
100A, 500V, gG, 22x58		ISZ22100
125A, 400V, gG, 22x58		ISZ22125

Cylindrical fuse links

▀ Cylindrical fuse link 10 x 38 mm for photovoltaic 900V characteristic gR



ISV10910

▀ Schrack-Info

- Cylindrical DC-fuses according to IEC- standard sizes 10 x 38 mm
- Characteristic gR

Size:	10 x 38
Characteristic:	gR
Rated current:	6 A - 20 A
Rated voltage:	900 V-DC
Body material:	ceramic
Material of contact parts:	CuZn28, gal.Ag

▀ 10 x 38 Dimensions

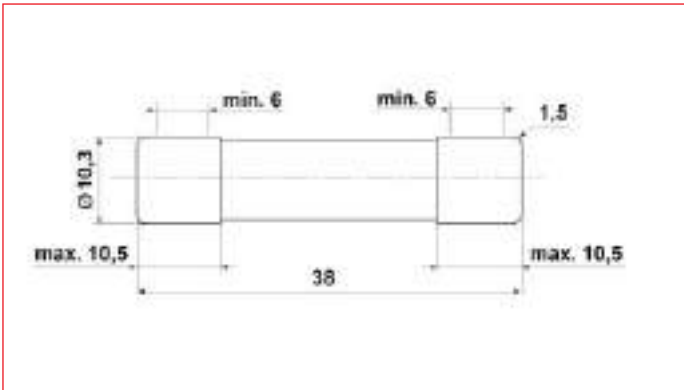

DESCRIPTION	AVAILABLE	ORDER NO.
6A, 900V, gR, 10x38		ISV10906
10A, 900V, gR, 10x38		ISV10910
12A, 900V, gR, 10x38		ISV10912
15A, 900V, gR, 10x38		ISV10915
20A, 900V, gR, 10x38		ISV10920

▀ Cylindrical fuse link 10 x 38 mm for photovoltaic 1000V characteristic gPV



ISV10016

▀ Schrack-Info

- Cylindrical PV-fuses according to IEC- standard sizes 10 x 38 mm
- Characteristic gPV

Size:	10 x 38
Characteristic:	gR
Rated current:	4 A - 20 A
Rated voltage:	1000 V-DC
Body material:	ceramic
Material of contact parts:	CuZn28, gal.Ag

▀ Cylindrical fuse link 10 x 38 mm for photovoltaic 1000V characteristic gPV

▀ 10 x 38 Dimensions

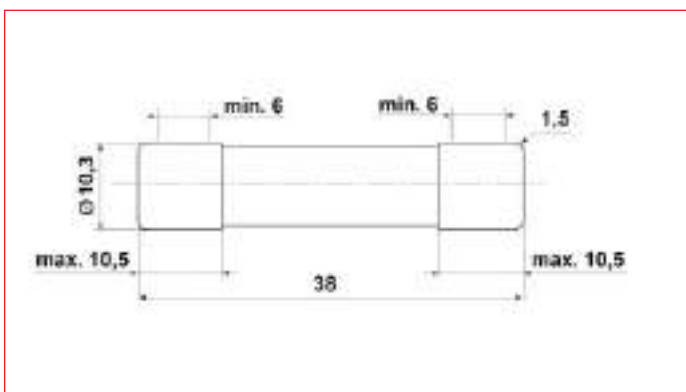



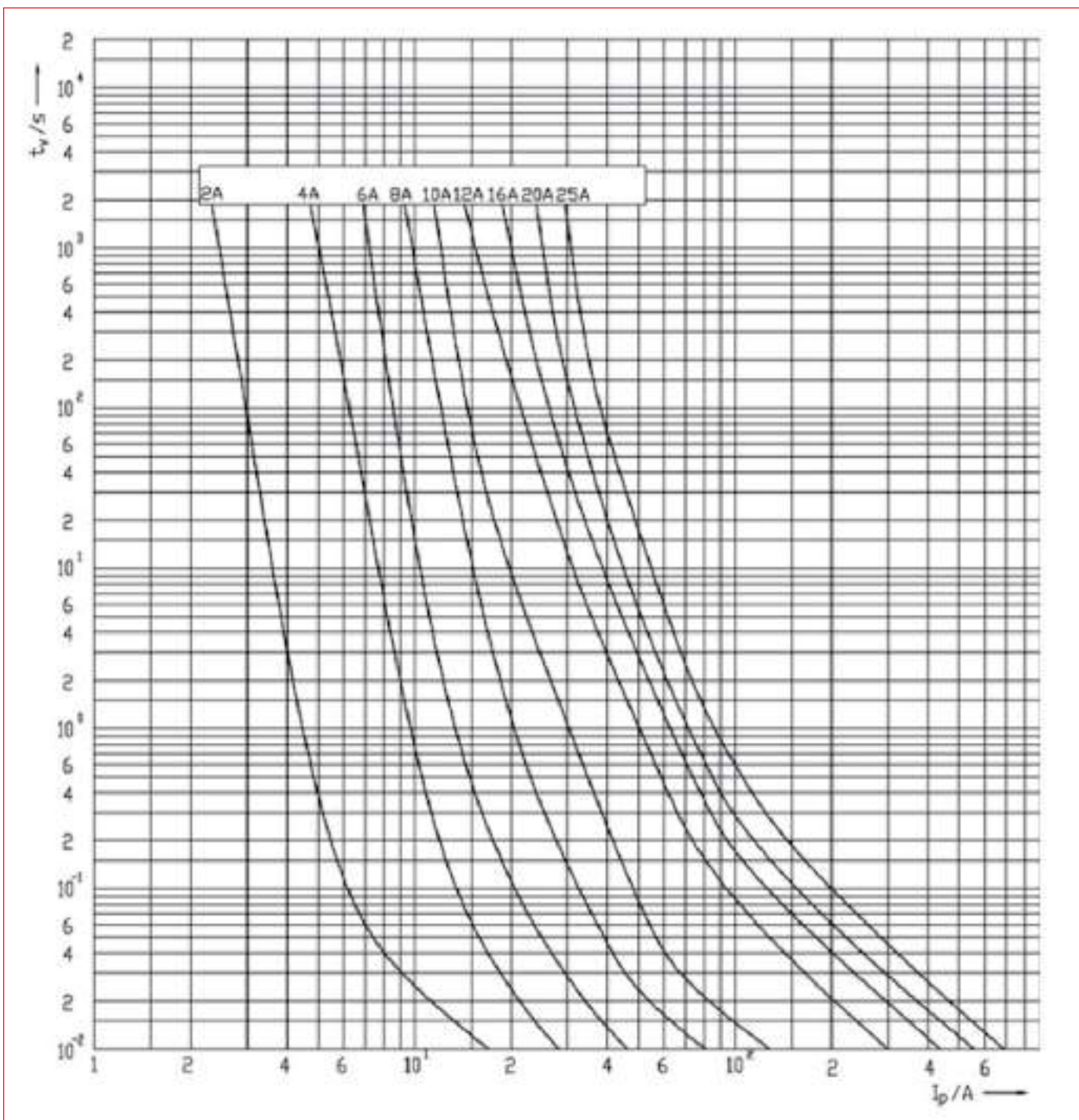

▀ 10 x 38 Characteristic gPV



Cylindrical fuse links

■ Cylindrical fuse link 10 x 38 mm for photovoltaic 1000V characteristic gPV

DESCRIPTION	AVAILABLE	ORDER NO.
4A, 1000V, gPV, 10x38		ISV10004
6A, 1000V, gPV, 10x38		ISV10006
8A, 1000V, gPV, 10x38		ISV10008
10A, 1000V, gPV, 10x38		ISV10010
12A, 1000V, gPV, 10x38		ISV10012
16A, 1000V, gPV, 10x38		ISV10016
20A, 1000V, gPV, 10x38		ISV10020

■ Cylindrical fuse link 10 x 38 mm characteristic gR



SI312130

■ Schrack-Info

- Cylindrical PV-fuses according in sizes 10 x 38 mm
- Characteristic gR

Size:	10 x 38
Characteristic:	gR
Rated current:	25 A
Rated voltage:	690 V-DC

■ 10 x 38 Dimensions

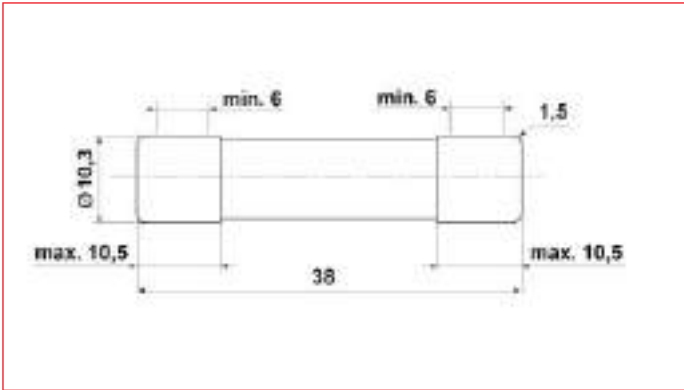

DESCRIPTION	AVAILABLE	ORDER NO.
25A, 690V, gR, 10 x 38		SI312130